

# Voice Mail System

## Installation Programming Manual

MN1000621E

### Table of Contents

<b>1. Call Processing Flow Chart</b> .....	1
<b>2. Installation</b>	
System Layout .....	3
Installation Procedures .....	5
<b>3. Voice Instruction Menu</b>	
System Program .....	7
Administrator Program .....	9
Mailbox Owner Program .....	11
<b>4. Program Explanations and Examples</b>	
Voice Message Recording .....	13
Extension Number Groups .....	15
Operator Number .....	17
Identification Code .....	19
Message Notification .....	21
Information Menus .....	23
Other Functions .....	25
<b>5. Appendix</b>	
Troubleshooting .....	27
Reference data for PBXs .....	29
User Information Form .....	30

# Call Processing Flow Chart

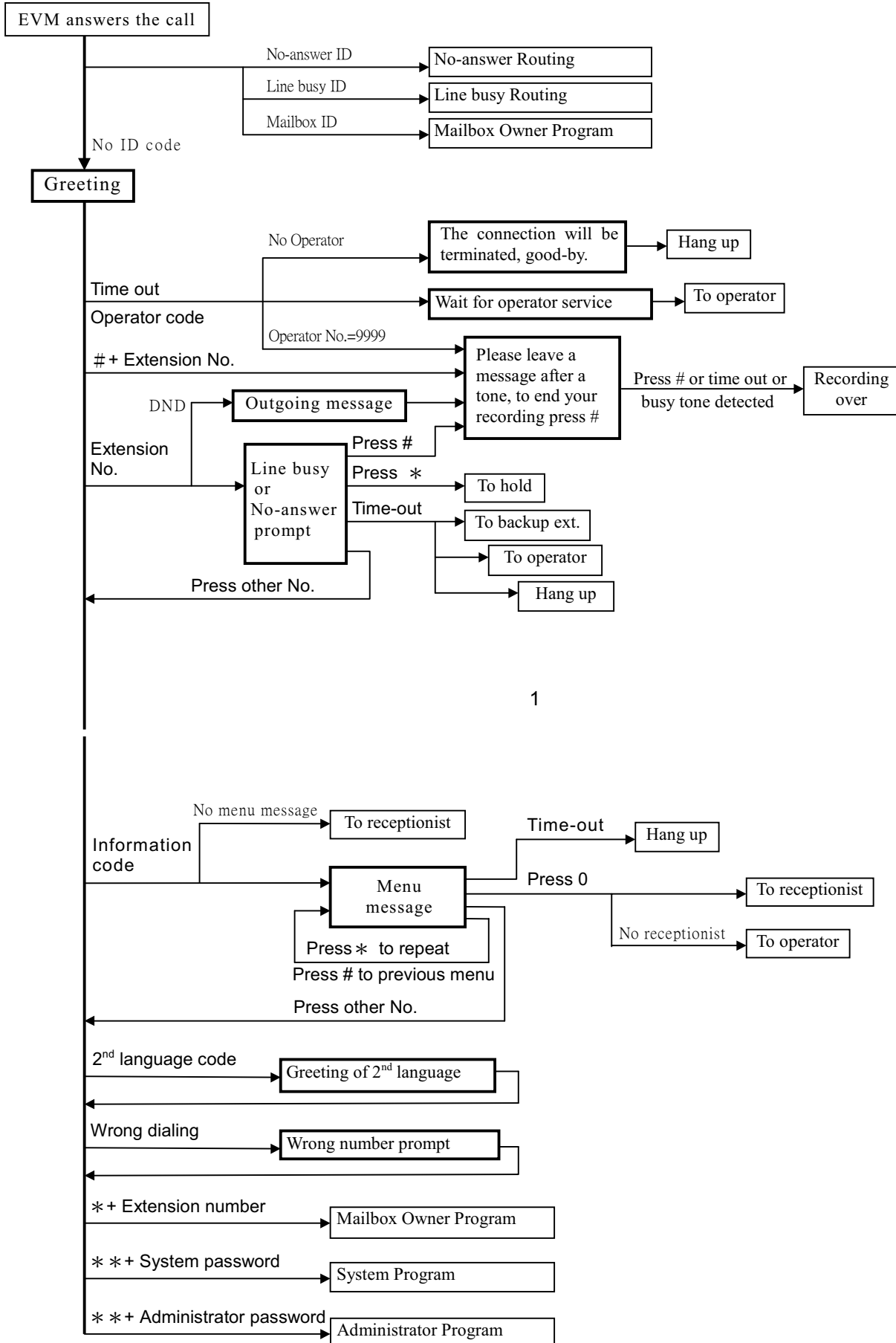

## System Layout -- EVM8100 EVM81002

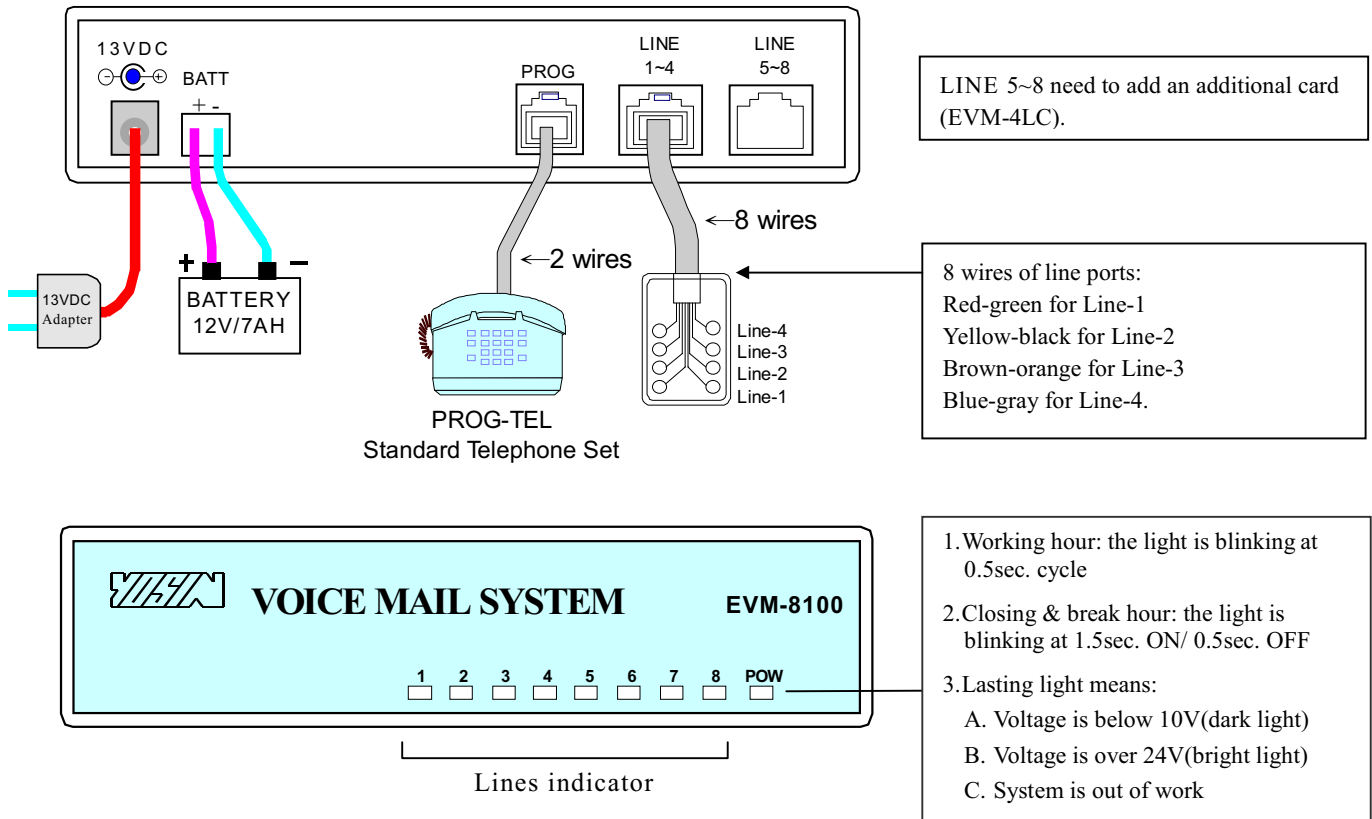

3

## System Layout -- EVM2020 EVM2045

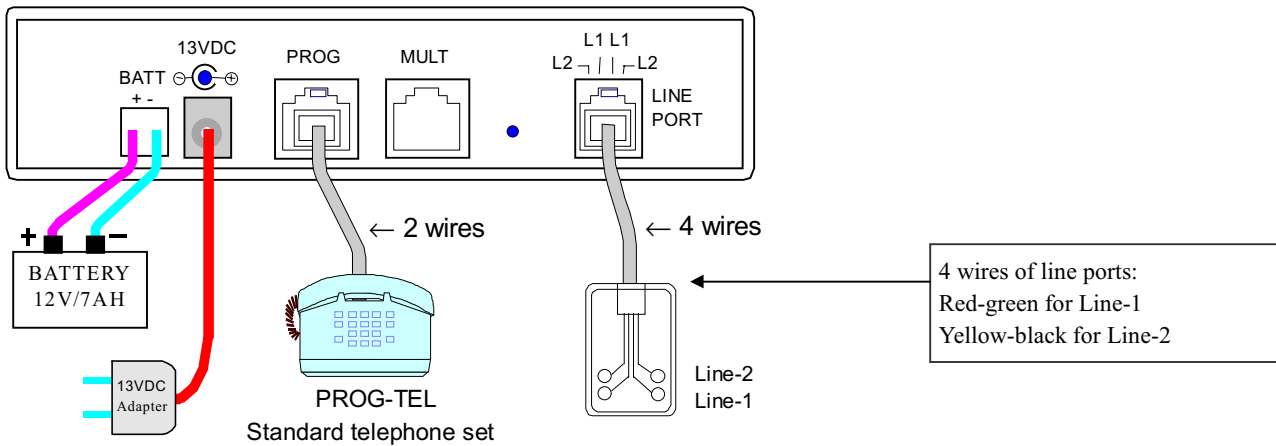

### ■ Specifications

	EVM2020	EVM2045	EVM8100	EVM81002
Voice storage capacity with FLASH-EPROM	2~2.5 hours	4.5~5.5 hours	10~12 hours	20~24 hours
SLT interface	2 Ports (Non-expandible)		4 to 8 Ports	
Power consumption: 13VDC	0.13A		0.2A (4 Ports) / 0.38A (8 Ports)	
Dimensions	25.5cm(L) x 15.5cm(W) x 4.2cm(H)		26.3cm(L) x 19cm(W) x 5.8cm(H)	

4

# Installation Procedure

## 1. Planning

Please refer to the Numbering Scheme of PABX system and the Usage Instruction for standard telephone, and then fill in the “User Information Form”. If there has any query, please refer to P. 13 ~ 26 for “Program Explanations and Examples”.

## 2. Installation

Please follow the System Layout to connect extension lines and power source. Meanwhile, keep eyes on the Pilot Lamp of Line 1, 2, .... They will be illuminated to indicate the number of Lines in EVM; afterward, they will be turned off as an indication that normal action now is available.

## 3. Enter the Program

On-site: Connect a standard telephone set to the PROG jack at rear board of EVM. When the receiver is pick-up the system plays the message: “welcome to the system program...”.

Remote: Dial into EVM from an external line or a PABX internal line. Press system password \* \*0 #0 #, and the system plays the message: “welcome to the system program...”.

## 4. Program Setting

Refer to the System Program and Administrator Program on pages 7-10 to : (1) record messages (2) enter the Variety of data listed on “User Information Form” (3)set the current time.

## 5. Exit the Program

During the Instruction Menu, press # to exit the program setting, and return to the Greeting.

## 6. Testing

Dial into EVM from an external line or PABX internal line, dial a busy extension and an available extension (do not answer) three times each from EVM to configure parameters of RingBack Tone, Busy Tone and Hook-Flash time and to test if the procedure is operating properly. If there is a problem, please refer to page 27 for troubleshooting.

## 7. Final Step

Pass the attached “Mailbox User Card” to the users. The extension users will initiate the mailbox.

Pass the attached “Administrator Operation Card” to the Administrator, and instruct him to switch messages for working hours, closing hours and to make recording of temporary announcement.

## ■ PABX Setting

(1) Set the Identification Code (2) set the ringing for incoming calls to EVM and set HUNT GROUP, preferably in the order of Line-1, Line-3, Line-2, and Line-4.

## ■ Note

- Press # to confirm that data has been entered correctly. If the data is entered incorrectly, please do not press # to confirm. Wait for 3 seconds before returning to the menu and select.
- When the extension number or the Information Menu number is less than 4 digits, please wait for 3 seconds, or press # to complete the entry, e.g. X #, XX #, XXX #.
- For special character \* - enter \*\*, # - enter \*1, A- enter \*2, B- enter \*3, C- enter \*4.

## ■ If you would like to re-install, the following program setting allows you to delete the previous settings:

Program	Explanations
SYS_1_00_0	Whole setting for the program returns to default. All the operator's numbers and pre-set holidays are deleted.
SYS_7_8_1_000	To delete Call Progress Tone (CPT) parameters and recovery to Auto-configuration
ADM_2_1_00(after voice)_0	To delete all the user recorded prompts
ADM_2_9_0000(after voice)_0	To delete all Information Menus message
ADM_5_0000_0000	To delete all number forwarding
ADM_6_0000_0000	To delete all receptionists of Information Menu
ADM_8_0000_000	To delete all mailboxes

# System Program

Press # to return to previous menu or to end data entry.

You could wait time out to previous menu or re-enter again while data entry incorrect.

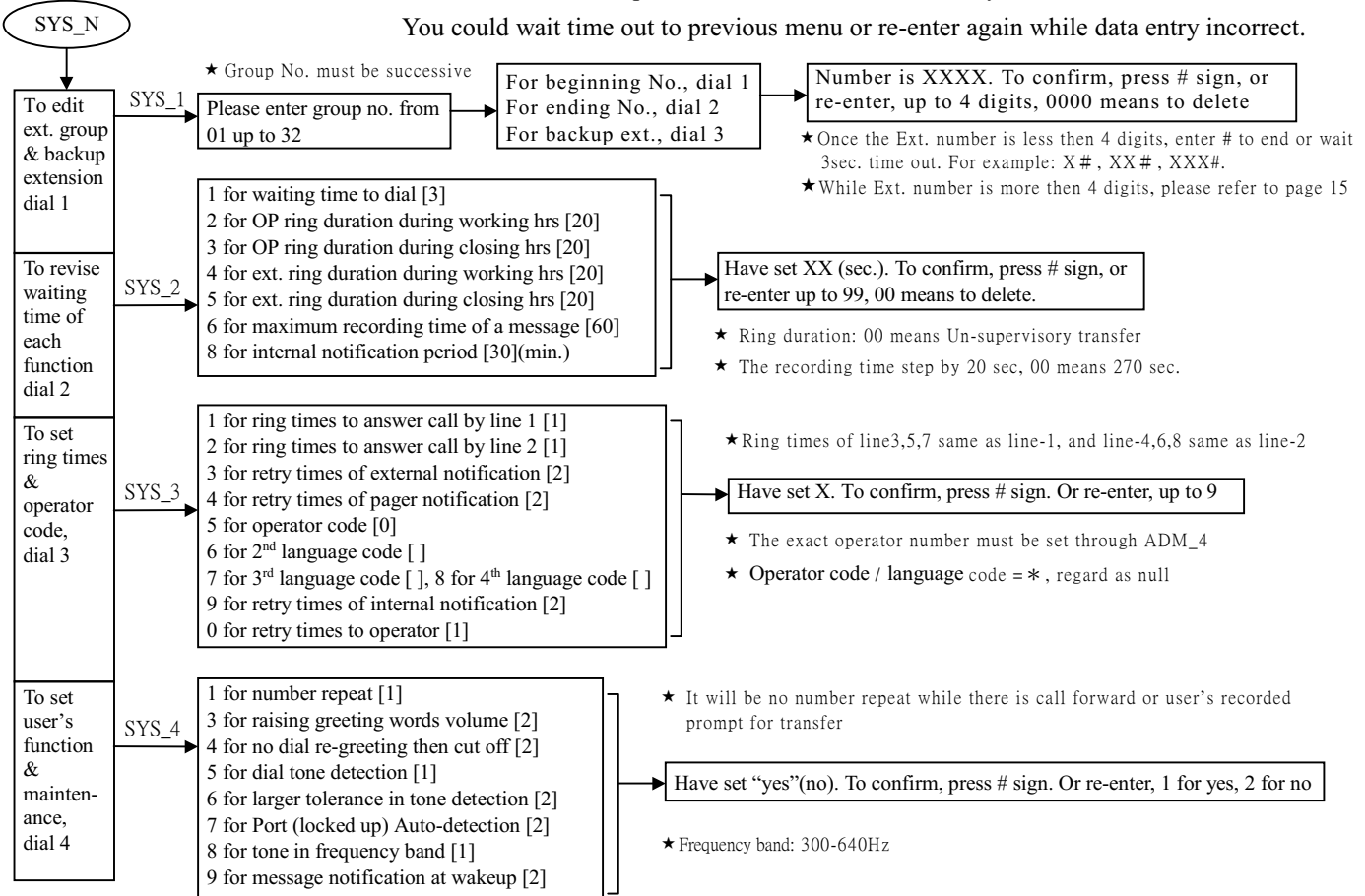

7

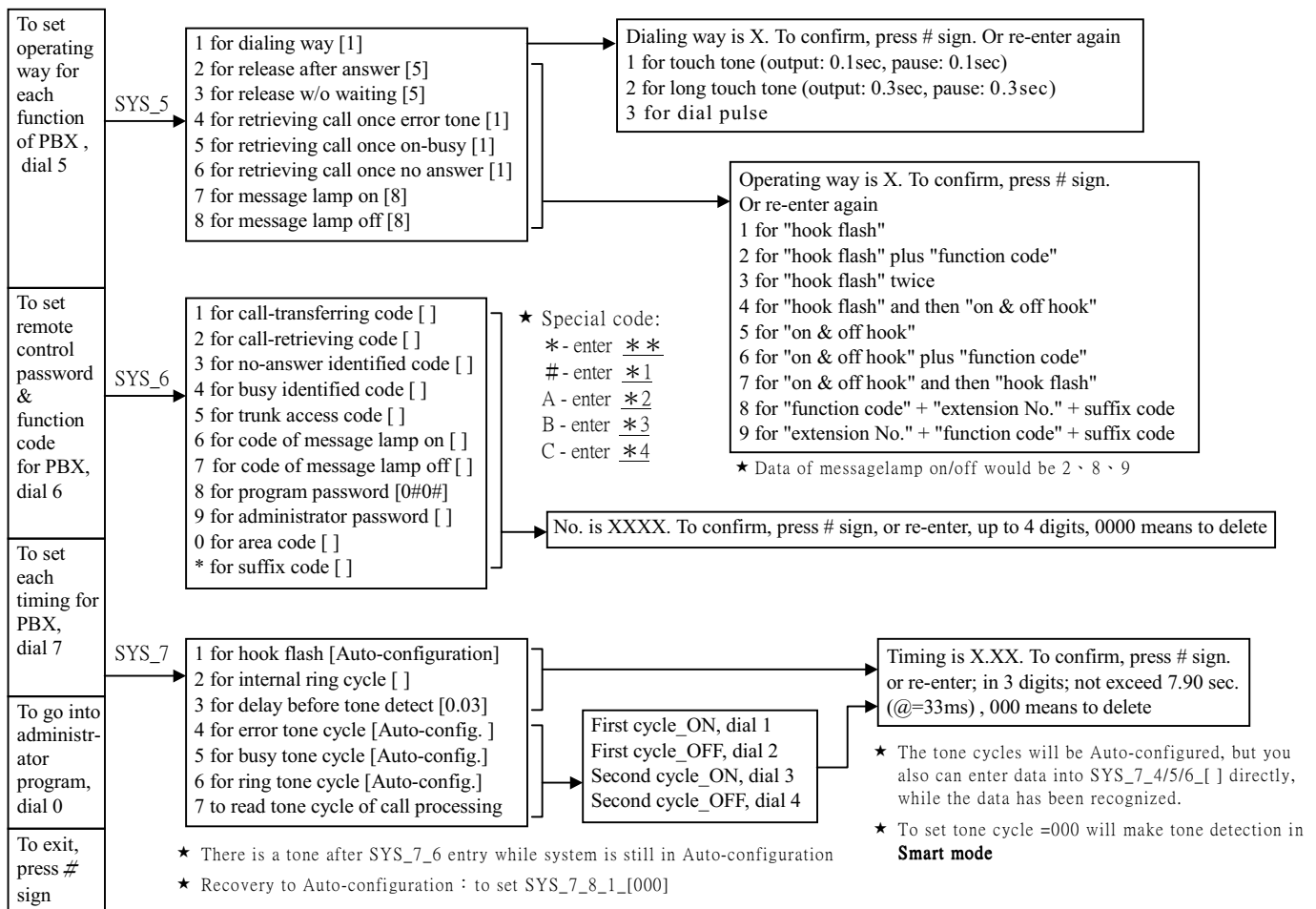

8

# Administrator Program

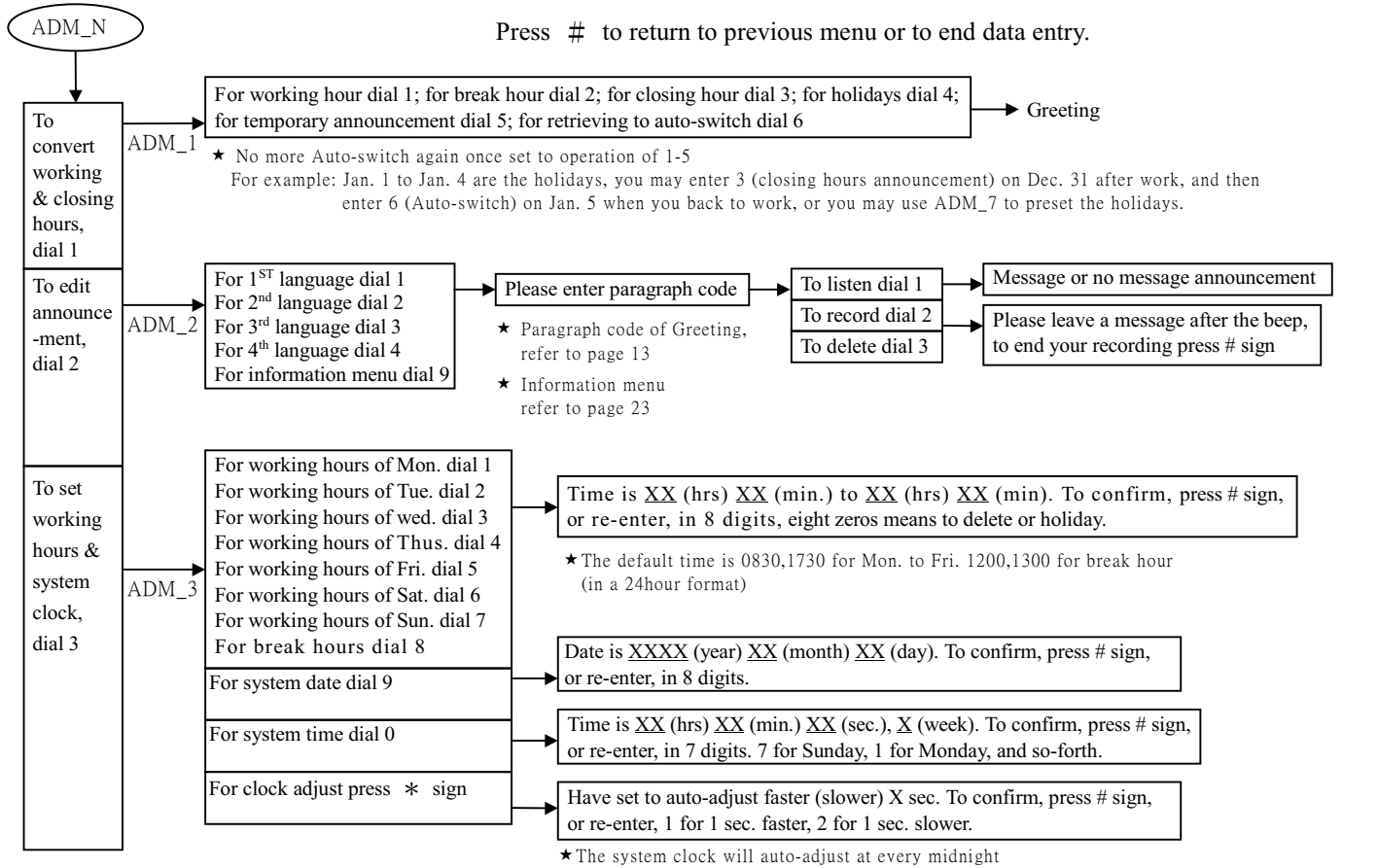

9

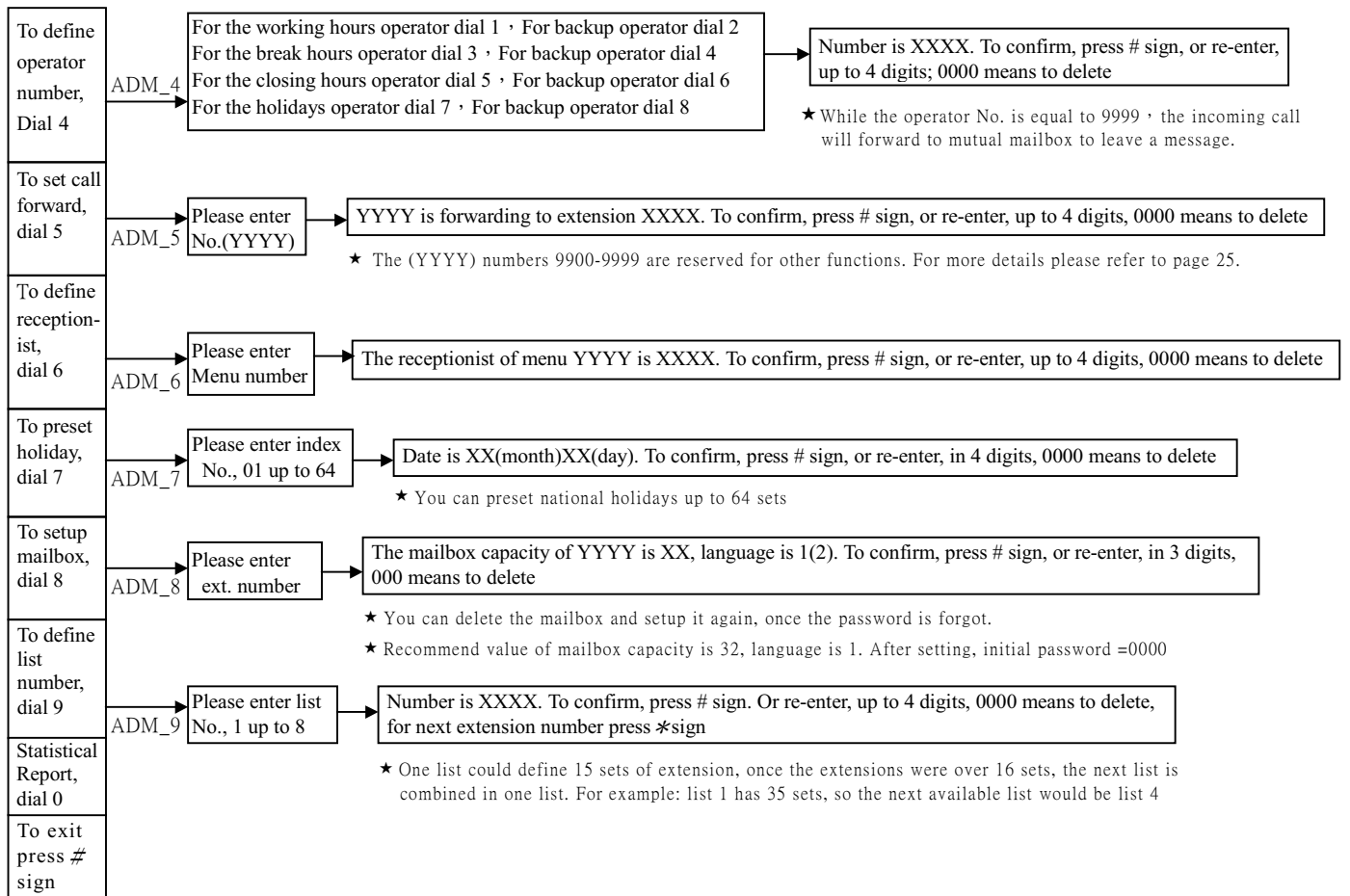

# Mailbox Owner Program

Press # to return to previous menu or to end data entry.

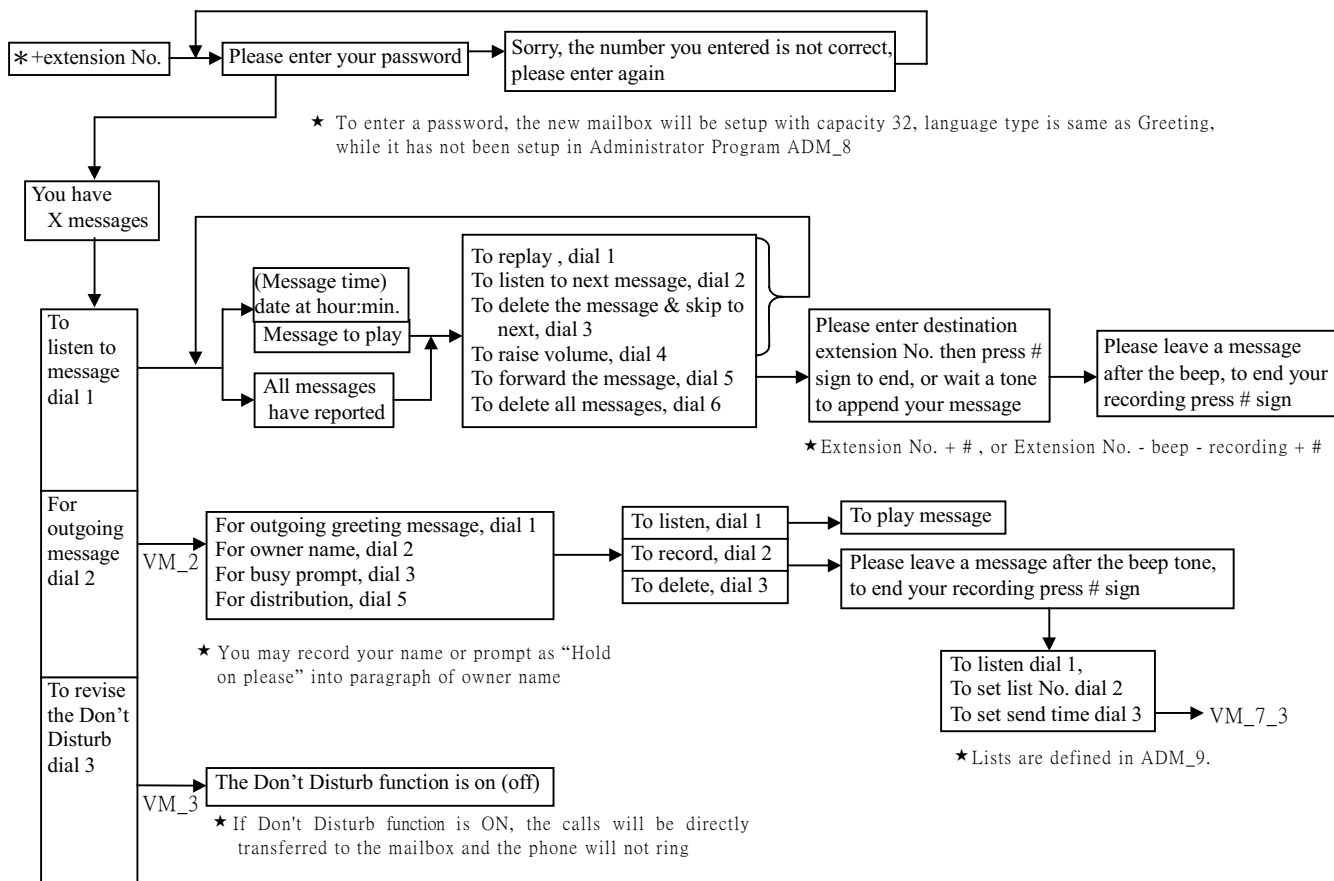

11

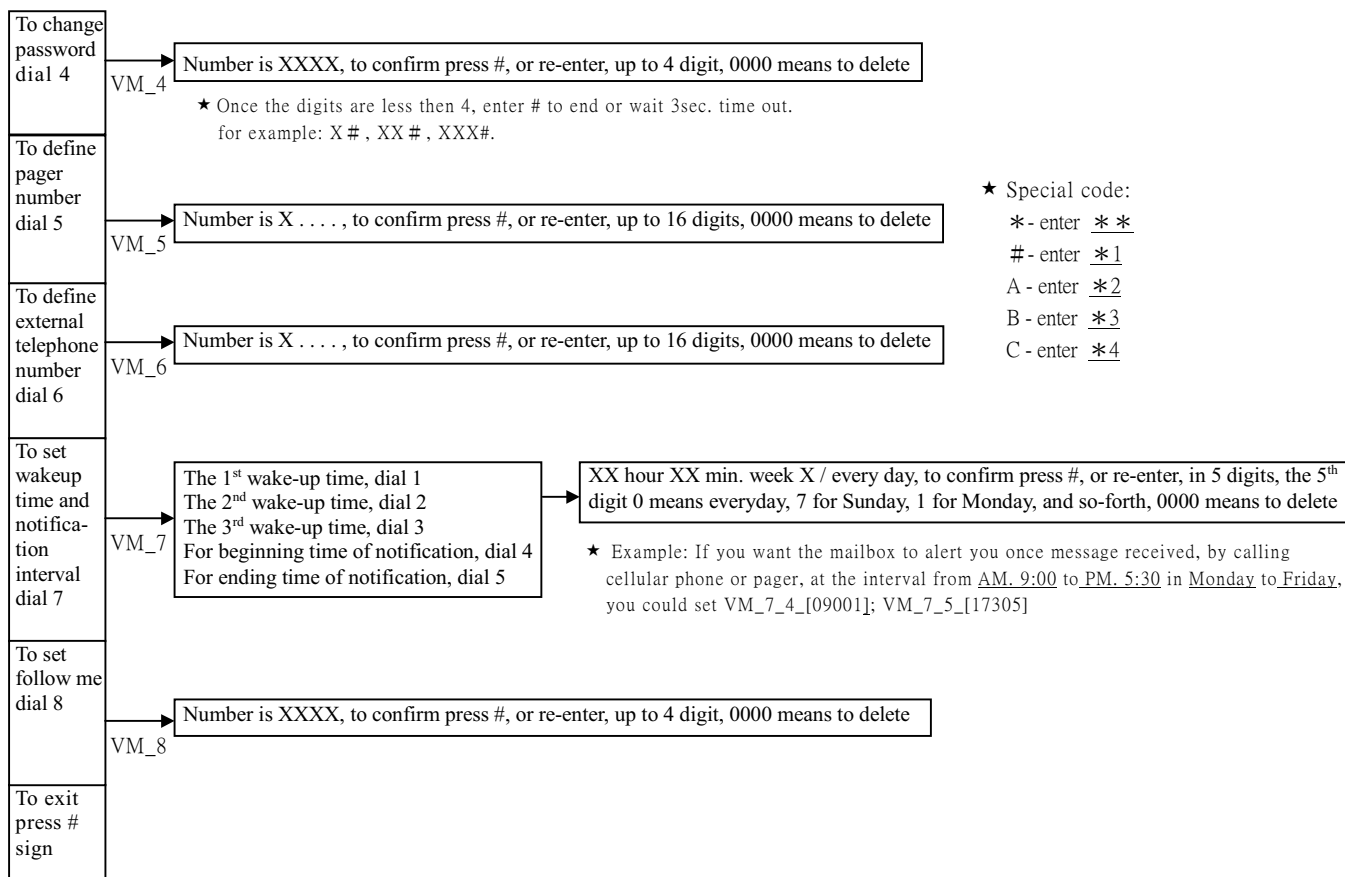

12

# Voice Message Recording

- To record/listen/delete all the messages, press 2 in the main menu of Administrator Program, then follow the instruction message to select:

Example 1: Record the Greeting for working hours in the native(1<sup>st</sup>) language.

Press 1 to select the native language → press the paragraph code 01 → press 2 to record → the beep → record message by talking into the receiver → press # to end.

Example 2: Record the Greeting for working hours in a second language.

Press 2 to select the second language → press the paragraph code 01 → press 2 to record → the beep → Record the message by talking into the receiver → press # to end.

In addition, the “Language Code SYS\_3\_6\_[]” for the second language must be set, so that when a caller is able to switch to the second language by pressing the language code during the Greeting in the native language.

- To change message, simply record again, there is no need to delete the previous message. If the recorded prompt message is deleted, EVM will play a built-in message.
- The built-in message for the native language is English, it may be recorded in other languages. The paragraph listed in the table below can be changed by recording.

code	Paragraph explanation	Built-in message
01	Greeting words during working hours	Please dial extension No., or wait for operator service
02	Greeting words during break hours	It is break hour now, please dial extension No.
03	Greeting words during closing hours	It is closing hour now, please dial extension No., or wait for operator service
04	Greeting words during holidays	It is closing hour now, please dial extension No.
05	Prompt for transferring	a. Please wait a moment!      b. please wait a moment for operator service
08	Operator busy during working hours	a. Sorry, the operator is busy now, please dial * sign to hold, or dial another extension No.
11	Operator busy during closing hours	
06	No-answer prompt during working hours	a. Sorry, the extension is busy now /call is unanswered, please dial * sign to hold, or wait for operator service.
07	Busy prompt during working hours	
09	No-answer prompt during closing hours	b. Sorry, the extension is busy now /call is unanswered, please dial * sign to hold, or dial another extension number. ( <i>The user recorded working hour prompts could be used for working hour &amp; close hour</i> )
10	Busy prompt during closing hours	

12	No-answer during working hours(w/ mailbox)	a. Sorry, the extension is busy now /call is unanswered, please dial * sign to hold, dial # sign to leave a message, or wait for operator service
13	Busy during working hours(w/ mailbox)	
15	No-answer during closing hours(w/ mailbox)	b. Sorry, the extension is busy now /call is unanswered, please dial * sign to hold, dial # sign to leave a message, or dial another extension number.
16	Busy during closing hours(w/ mailbox)	
18	Wrong number prompt during working hours	a. Sorry, the number you dialed is wrong number, please check and redial
19	Wrong number prompt during closing hours	b. Sorry, the number you dialed XXXX can't be identified, please check and redial.
20	To hang up	Sorry, this connection will be terminated, good-bye
21	Prompt after Information Menu	To repeat press *sign, to previous menu press # sign, or dial 0 for operator service
22	Message notification	Hello! There are messages in your mailbox, please enter your password to listen
23	Temporary announcement	
24	To start recording message	Please leave a message after a tone, to end your recording press # sign
25	Message over	All messages have reported
26	Input error	Sorry, the number you entered is not correct, please enter again
27	To confirm recording	To listen to message dial 1, to record again dial 2, to exit dial 3
28	To enter password	Please enter your password
29	Main menu of mailbox owner program	To listen to message dial 1,for outgoing message dial 2, to revise the Don't disturb dial 3, ...
30	To listen message	To replay dial 1, to listen to next message dial 2, to delete the message dial 3, to raise volume dial 4, ...
31	Outgoing messages	Outgoing greeting dial 1, owner name dial 2, message distribution dial 5
32	Call forward to mailbox at Don't Disturb	The Don't Disturb function is on
33	To cancel the Don't Disturb	The Don't Disturb function is off
34	To forward message	Please enter destination extension No. then press # sign to end, or wait a tone to append your message
35	To setup timer	For 1 <sup>st</sup> wake-up time dial 1, for beginning time of notification dial 4, for ending time of notification dial 5
36	Message of wake-up	Hello! The time you set is up
37	To listen/record/delete	To listen dial 1, to record dial 2, to delete dial 3
38	There are no messages	There are no messages in your mailbox
39	Mailbox is full	Sorry, the mailbox is full, no message more



# Extension Number Groups

- Extension number group is used for setting the range of extension number and assistant, dialing the extension number outside the range will be announced “Identification Failed”.
- The group number must be successive.
- Program ADM5\_[YYYY]\_[9000] can be used to set number YYYY as non-registered number; once the caller dials YYYY, it will be announced “Identification Failed”.
- Generally, PABX Extension Numbering Scheme has one type or several types listed below:

	Extension number	Program Setting
1	No more than 4 digits	Directly enter the extension number
2	More than 4 digits, but several numbers ahead are identical; it shall not exceed 4 digits with the prefix number excluded.	It shall set the Area Code as the prefix number. SYS_6_0_[ ] The Area Code must be excluded when entering extension number, operator’s number, Number forward, etc.
3	More than 4 digits, but several numbers ahead are identical; it exceeds 4 digits with the prefix number excluded.	Designate the extension number length by prefix number (without Mailbox function): Beginning number = <b>0 0 N N</b> Ending number.= <b>0 X Y Z</b> NN: Prefix number for this group of extension.
4	More than 4 digits and several numbers ahead are different.	X= the extension number length of the group, X=0 means flexible length Y= pause for 3 seconds after the Y <sup>th</sup> digit
5	It is the extension number existing among another linking line PABX (Link Extension)	Z= pause for 3 seconds again after the Z <sup>th</sup> digit, Z=0 means Un-supervisory transfer Z=* means tone detection in Smart mode

15

Example 1: Company ABC’s extension numbers go from 100~250 and from 30~39 (when the line is busy or is unanswered, and the caller did not dial another extension, the call is transferred to assistant’s extension – 100).

Where the extension numbers are less than 4 digits, the program setting is as follows:

- For 01 Group, beginning number 100, ending number 250: SYS\_1\_01\_1\_[100], SYS\_1\_01\_2\_[250]
- For 02 Group, beginning number 30, ending number 39, Assistant extension 100: SYS\_1\_02\_1\_[30], SYS\_1\_02\_2\_[39], SYS\_1\_02\_3\_[100]

Example 2: Company ACC’s extension numbers go from 611000~615999, and the Link Extension numbers go from 721000~728999. The number for the operator is 9 during working hours, and 611000 during closing hours. The program settings are as follows:

- 611000 ~ 615999 has two identical number ahead, set the Area Code as 61 : SYS\_6\_0\_[61]
- After excluding the Area Code from 611000 ~ 615999, set beginning number 1000 and ending number 5999 for 01 Group : SYS\_1\_01\_1\_[1000] , SYS\_1\_01\_2\_[5999]
- The Operator number during Working Hours is 9. Because it is single digit, no need to exclude the Area Code, set: ADM\_4\_1\_[9]
- The Operator number during closing hours is 611000. After excluding the Area Code, set: ADM\_4\_5\_[1000]
- For extension number 721000 ~ 728999, the prefix number is 72, length is 6 digits, CPT detection is initiated after the 6<sup>th</sup> digit with 3 seconds delay, set: SYS\_1\_02\_1\_[0072], SYS\_1\_02\_2\_[0606]
- 720000 ~ 720999 are unused numbers, set prefix number 720 as non-registered number: ADM\_5\_[720]\_[9000]
- 729000 ~ 729999 are unused numbers, set prefix number 729 as non-registered number: ADM\_5\_[729]\_[9000]

# Operator Number

- EVM will disconnects the call for time out after Greeting, if SYS\_3\_0\_[0] or unset operator number.
- EVM will disconnects the call for time out after Busy/No-answer message, if SYS\_4\_4\_[2].
- If the extension number of Duty Personnel is set via ADM\_5\_[Y]\_[X], and if Y is the same as Operator Code, then X is regarded as operator number.
- If there has been set an Area Code, then the input of operator number shall exclude Area Code, except the operator number having only a single digit.

## ■ Examples for operator number

Working hours		Closing hours		Break hours		Program Setting
Time-out	Dial 0	Time-out	Dial 0	Time-out	Dial 0	
To operator	To operator	To operator	To operator	To operator	To operator	➤ SYS_3_0_[2]: Re-call operator 2 times    ➤ SYS_3_5_[0]: Operator code is 0 ➤ ADM_4_1_[100]: During working hours, the Operator Number is 100 ➤ ADM_4_3_[300]: During breaking hours, the Operator Number is 300 ➤ ADM_4_5_[1000]: During closing hours, the operator Number is 1000
To operator	To operator	Dis-connect	To operator	To operator	To operator	➤ SYS_3_0_[2]: Re-call operator 2 times    ➤ SYS_3_5_[0]: Operator code is 0 ➤ ADM_4_1_[100]: During working hours, the Operator Number is 100 ➤ ADM_4_3_[300]: During breaking hours, the Operator Number is 300 ➤ ADM_4_5_[0000]: No operator, during closing hours ➤ ADM_5_[0]_[200]: During breaking/closing hours, dial 0 to Ext. 200
To operator	To operator	Dis-connect	To operator	Dis-connect	To operator	➤ SYS_3_0_[2]: Re-call operator 2 times    ➤ SYS_3_5_[0]: Operator code is 0: ➤ ADM_4_1_[100]: During working hours, the Operator Number is 100 ➤ ADM_4_3_[0000]: No operator, during breaking hours ➤ ADM_4_5_[0000]: No operator, during closing hours ➤ ADM_5_[0]_[200]: During breaking/closing hours, dial 0 to Ext. 200

17

Working hours		Closing hours		Break hours		Program Setting
Time-out	Dial 0	Time-out	Dial 0	Time-out	Dial 0	
To operator	To operator	Dis-connect	Dis-connect	Dis-connect	Dis-connect	➤ SYS_3_0_[2]: Re-call operator 2 times    ➤ SYS_3_5_[0]: Operator code is 0 ➤ ADM_4_1_[9]: During working hours, the Operator Number is 9 ➤ ADM_4_3_[0000]: No operator, during breaking hours ➤ ADM_4_5_[0000]: No operator, during closing hours
Dis-connect	To operator	Dis-connect	To operator	Dis-connect	To operator	➤ SYS_3_0_[0]: No Re-call operator    ➤ SYS_3_5_[0]: Operator code is 0 ➤ ADM_4_1_[100]: During working hours, the Operator Number is 100 ➤ ADM_4_3_[300]: During breaking hours , the Operator Number is 300 ➤ ADM_4_5_[200]: During closing hours, the operator Number is 200
Dis-connect	To operator	Dis-connect	Dis-connect	Dis-connect	To operator	➤ SYS_3_0_[0]: No Re-call operator    ➤ SYS_3_5_[0]: Operator code is 0 ➤ ADM_4_1_[100]: During working hours, the Operator Number is 100 ➤ ADM_4_3_[300]: During breaking hours, the Operator Number is 300 ➤ ADM_4_5_[0000]: No operator, during closing hours
Dis-connect	To operator	Dis-connect	Dis-connect	Dis-connect	Dis-connect	➤ SYS_3_0_[0]: No Re-call operator    ➤ SYS_3_5_[0]: Operator code is 0 ➤ ADM_4_1_[100]: During working hours, the Operator Number is 100 ➤ ADM_4_3_[0000]: No operator, during breaking hours ➤ ADM_4_5_[0000]: No operator, during closing hours
Dis-connect	Dis-connect	Dis-connect	Dis-connect	Dis-connect	Dis-connect	➤ SYS_3_5_[*]: No operator code ➤ ADM_4_1_[0000]: No operator, during working hours ➤ ADM_4_3_[0000]: No operator, during breaking hours ➤ ADM_4_5_[0000]: No operator, during closing hours

18

## Identification Code

- After EVM responding to incoming call, it will wait for PABX to transmit the Identification Code (ID code) and play different messages according to the code.

ID code received by EVM	EVM plays	Remark
No ID code recognized.	"Greeting"	
No-answer ID code: Prefix number + other numbers + extension number	"No-answer" prompt	To set Un-supervised Transfer: SYS_2_4_[00] , SYS_2_5_[00]
Line busy ID code: Prefix number + other numbers + extension number	"Line busy" prompt	
Mailbox ID code: 1. Prefix number + extension number 2. Extension number + suffix number 3. * + extension number	"Please enter your password"	After the password is entered, the caller enters into the Mailbox Owner Program.

- When PABX is transmitting ID Code too fast so that EVM is unable to receive a complete ID Code. Please add Pause ahead the PABX ID Code to delay the Code Transmission.
- When PABX is transmitting ID Code too slow, please select a longer Waiting Time for ID Code.

### ■ Waiting Time for ID code

Program	Explanation
ADM_5_9908_[A]xxx	A: Waiting time for ID code; A=0=1 second A=1=1.5 seconds A=2=2 seconds

( xxx entails other functions, please enter according to the original data.)

19

### ■ Setting ID Code

Item	Program	Explanation
No-answer ID code	SYS_6_3_[XXYY]	XX= prefix number (if there is only one digit, please enter 0 for the second digit.) For special character: *- enter <u>**</u> , #- enter <u>*1</u> , A- enter <u>*2</u> , B - enter <u>*3</u> , C - enter <u>*4</u> .
Line busy ID code	SYS_6_4_[XXYY]	YY= the number before extension number, that is, the ? digit ahead extension number is not extension number. YY=99 indicates that PABX will respond ID Code immediately after receiving the extension number. It should only apply to busy line identification.
Prefix number of Mailbox ID code	ADM_5_9920_[XXXX]	XXXX= prefix number
Suffix number of Mailbox ID code	ADM_5_9921_[XXXX]	XXXX= suffix number XXXX= # # indicates that it has extension number only

Example 1: A Brand PABX, when extension is being set to VOICEMAIL UNIT, it will send ID Code as follows:

VOICEMAIL UNIT dials an extension number — PABX sends out B6 before RingBack tone, meaning the extension dialed is available.  
— PABX sends out B7 before Busy tone, meaning the extension dialed is engaged.

VOICEMAIL UNIT answers a call — PABX sends out A4 + extension number, meaning the call was not answered.  
— PABX sends out A7, meaning there's an incoming call from an external line.

To set SYS\_6\_3\_[A402] — Prefix of No-answer ID Code is A4, and the front 2 digits are not extension number.

To set SYS\_6\_4\_[B799] — ID Code of busy line is B7, respond before Busy tone emission.

Example 2: F Brand PABX, the ID Code of No-answer is B + XX (Trunk number) + XXXX (Extension number)

To set SYS\_6\_3\_[B003] — Prefix of No-answer ID is B, and the front 3 digits are not extension number.

# Message Notification

## ■ Message Lamp(ML) Notification

	Operating way options	Operation Procedure	Remarks
1	ML-ON: SYS_5_7_[8] ML-OFF: SYS_5_8_[8]	ML-ON code → Ext. number → suffix code ML-OFF code → Ext. number → Suffix code	SYS_6_6_[ ML-ON code] SYS_6_7_[ ML-OFF code] SYS_6_*_[ Suffix code]
2	ML-ON: SYS_5_7_[9] ML-OFF: SYS_5_8_[9]	Ext. number → ML-ON code → Suffix code Ext. number → ML-OFF code → Suffix code	
3	ML-ON: SYS_5_7_[0] ML-OFF: SYS_5_8_[0]	In accordance with ADM_5_9930_[XXXX] X: 0= On-Hook 1= Hook-Flash 2= Ext. number 3= ADM_5_9931_[ 1st Function code] 4= ADM_5_9932_[ 2nd Function code]	Example: Operation for ML-ON: Pick up handset → Hook-Flash → *1 → Ext. number ➤ SYS_5_7_[0] ➤ ADM_5_9930_[132]: operation procedure ➤ ADM_5_9931_[* 1]: ML-ON code
4	ML-ON: SYS_5_7_[*] ML-OFF: SYS_5_8_[*]	In accordance with ADM_5_9933_[XXXX] X: 0= On-Hook 1= Hook-Flash 2= Ext. number 3= ADM_5_9934_[ 1st Function code] 4= ADM_5_9935_[ 2nd Function code]	Operation for ML-OFF: Pick up handset → Hook-Flash → #1 → Ext. number ➤ SYS_5_8_[*] ➤ ADM_5_9933_[132]: operation procedure ➤ ADM_5_9934_[# 1]: ML-OFF code

21

## ■ Pager Notification: Retry Times SYS\_3\_4\_[ ], with 6.5-minute intervals.

- The message code after pager number can be entered by the mailbox user, or by using a common message code. (the pager number in mailbox 9999 = the common message code)

## ■ External Notification: Retry Times SYS\_3\_3\_[ ], with 6.5-minute intervals.

## ■ Internal Notification: Retry Times SYS\_3\_9\_[ ], Retry Intervals SYS\_2\_8\_[ ]

## ■ Notification Options

Item	Program	Explanation
Do not Disturb	ADM_5_9900_[XXXX]	X: 0= ML-ON, 1= Pager, 2= External phone, 3= Internal ringing Default = 021 (1 <sup>ST</sup> ML-ON, 2 <sup>nd</sup> External phone, 3 <sup>rd</sup> Pager)
Line busy	ADM_5_9901_[XXXX]	Default = 03 (1 <sup>st</sup> ML-ON, 2 <sup>nd</sup> Internal ringing)
No-answer	ADM_5_9902_[XXXX]	Default = 0 (ML-ON only)

- In mutual mailbox (9999), there are no notification options for pager and external phone, and the extension number of internal ringing notification is not 9999 but set in VM\_8.

## ■ Related programs

- ADM\_5\_9909\_[ ]: Function code for internal dialing (e.g. V4)
- SYS\_6\_5\_[ ]: COL access code

22

# Information Menus

- EVM contains 4 levels and 256 sections of menus (EVM2020 contains only 9 menus). An extension number of receptionist can be allocated for each menu section.
- During (or after) the menu message, press \* to repeat, press # for previous menu, dial 0 to be transferred to the receptionist for this menu (if none exist transfer to the operator), dial 1-9 for the next level of menu messages or to the receptionist ( if the menu message does not exist), or dial an extension number (if there is no menu message and receptionist).
- The menu number is the number dialed from Greeting to this menu, as shown on the Figure below.

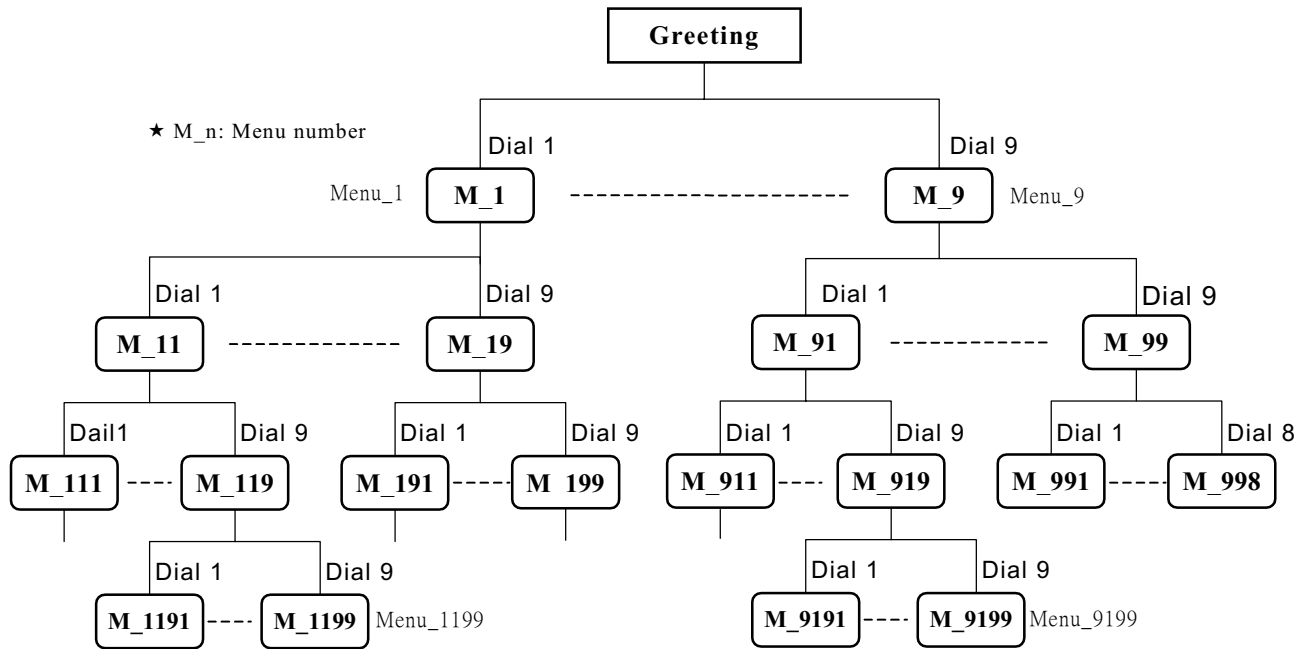

23

- After the completion of playing menu message, EVM plays the “prompt after Information Menu”. The language type will be set by ADM\_5\_991[Y][X]; Y= first digit of the menu number  
Language type X: 1= native language, 2= the second language, 3= the third language, 4= the fourth language.

Example: Extension number inquiry

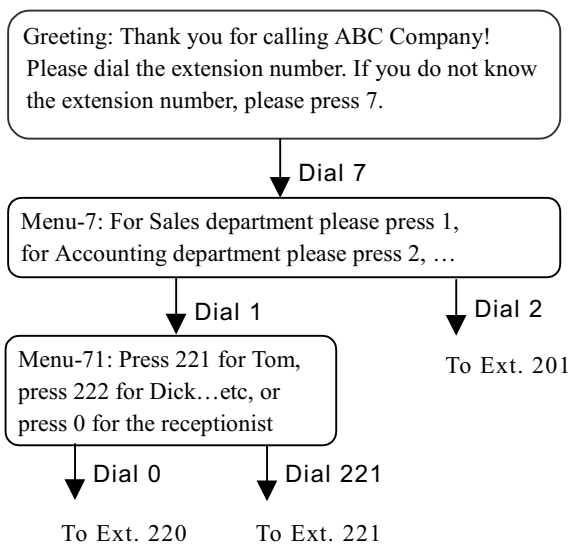

Programming:

- ADM\_5\_991[7][1]: language type for Menu-7/Menu-71
- ADM\_2\_9\_[7][2]: to record message for Menu-7
- ADM\_2\_9\_[71][2]: to record message for Menu-71
- ADM\_6\_[71][220]: to set receptionist for Menu-71
- ADM\_6\_[72][201]: to set receptionist for Menu-72
- Menu-712 without receptionist and voice message

## Other Functions

Program	Explanation
ADM_5_9900_[XXXX]	See "Message Notification" on page 22
ADM_5_9901_[XXXX]	See "Message Notification" on page 22
ADM_5_9902_[XXXX]	See "Message Notification" on page 22
ADM_5_9907_[XXXX]	The Pickup Code If such a code has been pre-entered, and EVM puts the call through Un-supervisory transfer. When the preset ringing time for Pickup is expired, EVM will retrieve the unanswered call via "Pickup Code + Extension number" method.
ADM_5_9908_[ABCD]	A: Waiting time for ID code. (For more details please refer to page 19.) B: To increase the sensitivity of Call Progress Tone detection for internal lines. C: To increase the sensitivity of Call Progress Tone detection for external lines. 0=0db(default) 1=2db 2=4db 3=6db 4=8db 5=10db 6=12db 7=14db D: 0=The user may initiate the new mailbox (default); 1= the user is prohibited from initiating the new mailbox.
ADM_5_9909_[XXXX]	Function code for internal dialing; Some PABX (e.g. V4) requires the user to enter functional code first before dialing the extension number. This is used for EVM's notifying extensions of messages.
ADM_5_991[Y]_[X]	Language type of "Prompt after Information Menu" , see "Information Menus" on page 24.
ADM_5_[YYYY]_9000	To set number YYYY as non-registered number.
ADM_0_[X]	Statistic Report of the Calls X: 1= Incoming call 2= Information Menu 3= Extension busy 4= Extension No-answer 5= Operator busy

SYS_2_7_[XX]	XX: ringing time for Pickup The time should be short, and shorter than the ringing time set by PABX, to prevent Pickup calls by mistakes.
SYS_4_9_[X]	X: 1= wake up call together with Message Notification, 2= wake up call without Message Notification (default)
SYS_4_0_[X]	X: 1= Silent compression (default), 2= non-silent compression.
SYS_9	Report of EVM version.

## Troubleshooting

Problem	Possible cause and solution
It will intermittently play the Leaving Message of Mailbox.	<ul style="list-style-type: none"> <li>Noise interference exists. If this cannot be fixed, set "non-silent compression SYS_4_0_[2]" to improve the situation; but the voice capacity will decrease by 20%.</li> </ul>
EVM does not pick up calls.	<ul style="list-style-type: none"> <li>If the POW lamp is not flashing, please check the power supply.</li> <li>Please check the wiring and make sure the incoming ringing is correct.</li> <li>PABX locked the extension port. Please set the Port Auto-detection. SYS_4_7_[2]</li> </ul>
EVM responds after External line 2 ~ 3 rings.	<ul style="list-style-type: none"> <li>This is normal. Set the "ring times SYS_3_1_[0]" for improvement.</li> </ul>
Immediate conversation over the phone is inaccessible after the called responds to the call.	<ul style="list-style-type: none"> <li>This is normal while the EVM is waiting. Use the Pickup code or ID code to allow calls to go through Un-supervise Transfer.</li> <li>EVM has not finished Auto-configuration yet.</li> </ul>
EVM always announces that the number dialed is faulty when in fact the line is busy, and vice versa.	<ul style="list-style-type: none"> <li>Please exchange the parameters for Error tone with the Busy tone.</li> </ul>
EVM announcement repeats: "Hold on, please" every 4 seconds, and the call is not on hold.	<ul style="list-style-type: none"> <li>Hook-Flash time is too short. SYS_7_1_[ ]</li> <li>Occasional occurrence – insufficient DTMF Receiver for PABX. ※</li> </ul>
EVM announcement repeats: "Hold on, please" every 4 seconds, and the call is being held.	<ul style="list-style-type: none"> <li>PABX Dial Tone frequency is outside the detection range (300 ~ 640 Hz), please set not to detect the frequency. SYS_4_8_[2]</li> <li>Occasional occurrence – insufficient DTMF Receiver for PABX. ※</li> </ul>
After "Hold on, please" has been announced, the call is disconnected.	<ul style="list-style-type: none"> <li>The Hook-Flash time set under EVM is too long. Where the Hook-Flash time is less than 0.13 seconds, EVM does not Auto-configuration, it must be entered manually.</li> </ul>
Extension number is correct, but EVM announces "Wrong number" or "Line busy".	<ul style="list-style-type: none"> <li>Dialing way is incorrect. SYS_5_1_[ ]</li> <li>Function code for call transfers is incorrect. SYS_6_1_[ ]</li> <li>PABX requires longer DTMF. Please set SYS_5_1_[2]</li> <li>Occasional occurrence – insufficient DTMF Receiver for PABX. ※</li> </ul>

27

EVM fails to announce that the called line is busy or is no answering.	<ul style="list-style-type: none"> <li>If the CPT is delayed or reminder tone exists before the CPT, please set to delay the detection of CPT. SYS_7_3_[ ]</li> <li>If the frequency of CPT is outside the detection range (300 ~ 640Hz), please select not to detect the CPT frequency. SYS_4_8_[2]</li> <li>CPT is irregular, please set larger tolerance for CPT detection. SYS_4_6_[1]</li> <li>CPT is too weak, please set the detection sensitivity of internal CPT. ADM_5_9908_x[ ]xx</li> <li>Key Telephone system has been set to Voice Call, please change it to ringing.</li> <li>Function code is required to retrieve the external line, or the procedure of retrieval is incorrect. SYS_6_2_[ ], SYS_5_5_[ ], SYS_5_6_[ ]</li> <li>Hook-Flash time is either too short or too long. SYS_7_1_[ ]</li> </ul>
Others	Use the hand-free of the PROG-TEL, press # to exit program setting and return to the Greeting. When the EVM finished playing the message and silence resumes, the procedure of the Line-1 transfer can be monitored through the speaker of the PROG-TEL to pin-point the problem.

※ DTMF Receiver in PABX is inadequate. The suggested solution is as follow:

- Increase the installation of DTMF Receiver for PABX.
- To set program for EVM to Dial Pulse (DP) Transmission.
- Disperse the Extension Line of EVM in several Interface Cards of PABX. (For example, every SLT Card of KX-TD contains only two-circuit DTMF Receiver.)

28

## Reference data for PBXs

You could just setup Extension Number Group, operator number and working hours to EVM for most PBX, but for some PABXs you may need to set function code and operating way as below:

PABXs	Operating way			Function code		Others
LUCENT PROLOGIX	SYS_5_4_[3]	SYS_5_5_[3]	SYS_5_6_[3]			
NAKAYO 64IS/88IS	SYS_5_4_[6]	SYS_5_5_[6]	SYS_5_6_[6]		SYS_6_2_[ ]	
NEC ADK/NDK	SYS_5_4_[5]	SYS_5_5_[5]	SYS_5_6_[5]			SYS_5_2_[5] SYS_5_3_[4]
Nitsuko UXE-128	SYS_5_4_[4]	SYS_5_5_[4]	SYS_5_6_[4]			
NORSTAR	SYS_5_4_[2]	SYS_5_5_[2]	SYS_5_6_[2]	SYS_6_1_[* 70]	SYS_6_2_[2]	SYS_4_5_[2]
Panasonic A	SYS_5_4_[5]	SYS_5_5_[5]	SYS_5_6_[5]			
Panasonic ICX						SYS_4_8_[2]
ROLM CBX9751				SYS_6_1_[* 7]	SYS_6_2_[* 1]	

29

## User Information Form 1/2

Company:	Tel:	Contact:	ADM password:	SYS password:
PABX:	Ext. No. of EVM	/	/	/

### Main data

### Information menus

Main data			Information menus		
Dial Tone Detection	Dialing way	Hook-Flash Time	Menu No.	Receptionist	Msg
SYS 4 5 [1 ]	<b>SYS 5 1 [1 ]</b>	SYS 7 1 [ ]			
Frequency Detection	Release after answer				
SYS 4 8 [1 ]	<b>SYS 5 2 [5 ]</b>				
Code of call transfer	Release w/o waiting	Delay before tone detection			
<b>SYS 6 1 [ ]</b>	<b>SYS 5 3 [5 ]</b>	SYS 7 3 [ ]			
Code of retrieving call	Retrieving call, Error Tone	Error Tone, SYS 7 4 _			
<b>SYS 6 2 [ ]</b>	<b>SYS 5 4 [1 ]</b>	[ ] [ ] [ ] [ ]			
Busy ID code	Retrieving call, Line Busy	Busy Tone, SYS 7 5 _			
<b>SYS 6 4 [ ]</b>	<b>SYS 5 5 [1 ]</b>	[ ] [ ] [ ] [ ]			
No-Answer ID code	Retrieving call, No-Answer	Ring Back Tone, SYS 7 6 _			
<b>SYS 6 3 [ ]</b>	<b>SYS 5 6 [1 ]</b>	[ ] [ ] [ ] [ ]			
ML-ON code	Operating for ML-ON	Port (locked up) Auto-detection			
SYS 6 6 [ ]	SYS 5 7 [8 ]	SYS 4 7 [2 ]			
ML-OFF code	Operating for ML-OFF				
SYS 6 7 [ ]	SYS 5 8 [8 ]				
Suffix code of ML					
SYS 6 * [ ]					
COL access code	Function code for intercom				
SYS 6 5 [ ]	ADM 5 9909 [ ]	ADM 5 9908 [ ] [ ] [ ] [ ]			

30



# User Information Form 2/2

Working Hours ADM\_3

Extension Number Group SYS\_1

ADM\_5

From / To		Grp	Beginning	Ending	Backup	Grp	Beginning	Ending	Backup	Number	Forward	
Mon.	/	01				21						
Tue.	/	02				22						
Wed.	/	03				23						
Thu.	/	04				24						
Fri.	/	05				25						
Sat.	/	06				26						
Sun	/	07				27						
Break	/	08				28						
ADM_4_		09				29						
Operator Number		10				30						
Working hours	1:	11				31						
	2:	12				32						
Breaking hours	1:	13				Area code    SYS_6_0_[    ] Operator code    SYS_3_5_[    ] Number repeat    SYS_4_1_[    ]     						
	2:	14										
Closing hours	1:	15										
	2:	16										
Holiday	1:	17										
	2:	18										
		19										
		20										